

Dynapump

# PT-Series

*We're Serious About Sealless Performance*



**Sealless, Leakproof Regenerative Turbine Pumps**

## Dynapump

### *Canned Motor Pumps*

Canned Motor Pumps integrate pumps with motors to provide an effective sealless, leakproof pumping system in a highly compact package. The motor windings are protected from the pumped fluid by a Stainless Steel containment shell, and O-Rings selected for each application seal all stationary pressure-containing joints. A small portion of the pumped flow is circulated through the motor to lubricate the bearings and cool the motor. There are no mechanical seals to fail or leak.

Chempump has been building Canned Motor Pumps since the early 1950's for a wide variety of Industrial, Chemical Process and Nuclear applications. The PT Series is a cost-effective line of Regenerative Turbine Canned Motor Pumps built on the heritage of our years of experience and are designed for Industrial applications where leakage from packing or mechanical seals is to be avoided.

## Dynapump

### *Design Features*

1. Pump casing is provided in investment cast 316 Stainless Steel for corrosion resistance, high integrity and optimum hydraulic efficiency.
2. Precision 316 Stainless Steel Impeller provides automatic hydraulic balance for pump operation with no axial thrust load.
3. Dual-voltage motor winding provides for operation at both 60 and 50 Hertz frequencies with Class H insulation suitable for VFD operation.
4. 316L Stainless Steel Stator Liner provides isolation of the motor winding from the pumped fluid.
5. 316L Rotor Liner protects the underlying rotor iron from the pumped fluid.
6. Solid fill provides excellent thermal management of the motor winding heat, evenly distributing heat to the stator liner and the external stator band.
7. Thrust washers provide a "bump" surface to handle transient axial loads during start-up and abnormal operation.
8. Carbon graphite sleeve bearings support the rotor during operation with a thin layer of fluid. Unlike ball bearings with a finite life, these bearings will last indefinitely if the pump is run continuously with clean liquid.

## Dynapump

### *Leakproof, Sealless Pumps*

The Dynapump PT Series Regenerative Turbine Canned Motor Pump is specifically designed to provide leak-proof service for fluid circulation applications. The materials of construction provide the capability of handling a wide range of coolants, deionized water and other Industrial liquids.

A range of motor sizes is available to match the specific needs of the hydraulic requirements and the pumped liquid. Other pump configurations, including the JS Series, Centrifugal Canned Motor Pumps are also available.

## Dynapump

### *Materials of Construction*

Casing & Adapter	316 Stainless Steel
Impeller & Impeller Key	316 Stainless Steel
Stator Liner	316L Stainless Steel
Rotor Shaft	316 Stainless Steel
Rotor Liner	316L Stainless Steel
Sleeve Bearings	Carbon Graphite Type B
O-Rings	Viton or EPDM
Motor End Bell	Die-Cast Aluminum

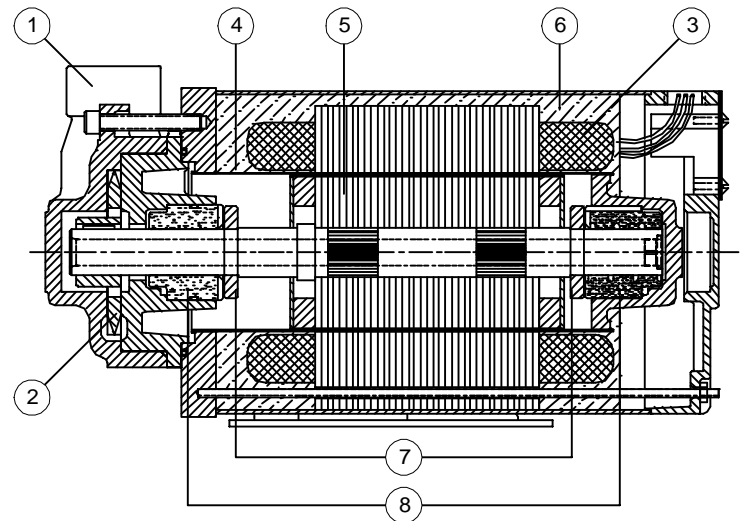

Dynapump PT Series Cross Section

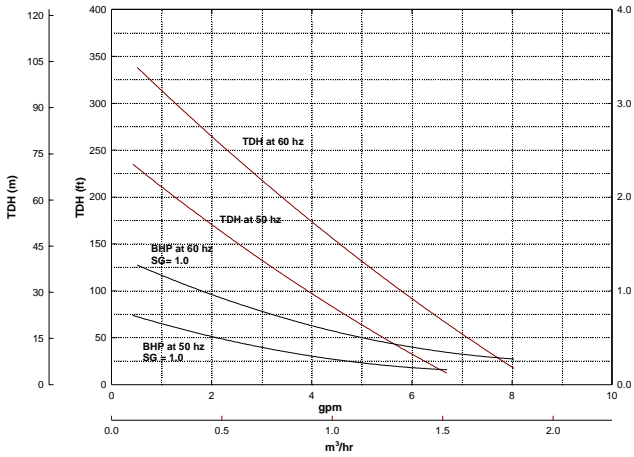

PT3 3450 & 2880 Curve

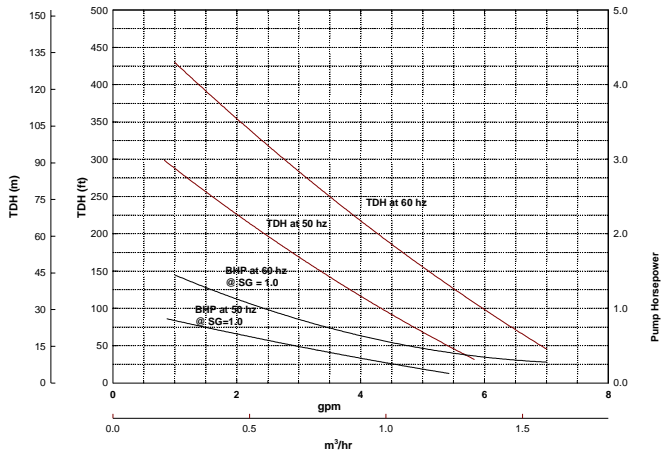

PT4 3450 & 2880 Curve

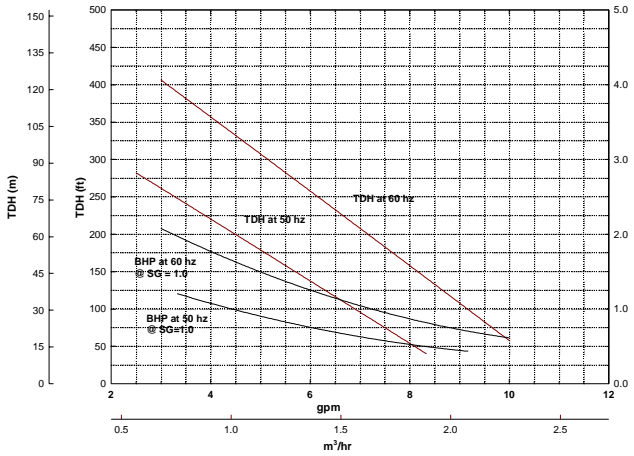

PT6 3450 & 2880 Curve

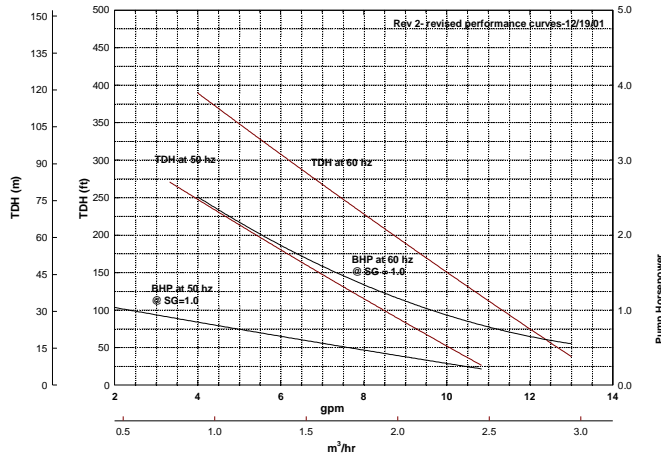

PT8 3450 & 2880 Curve

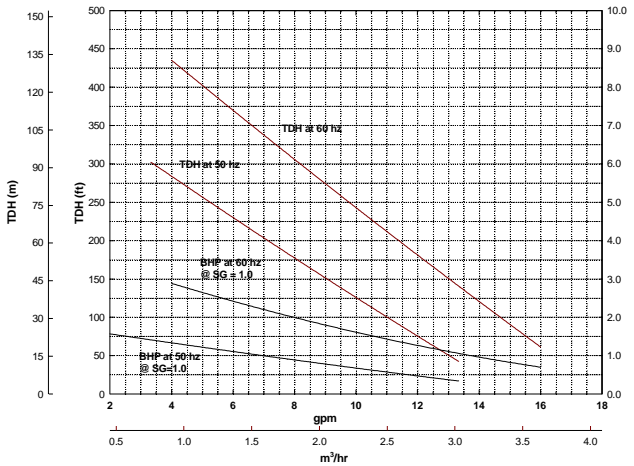

PT10 3450 & 2880 Curve

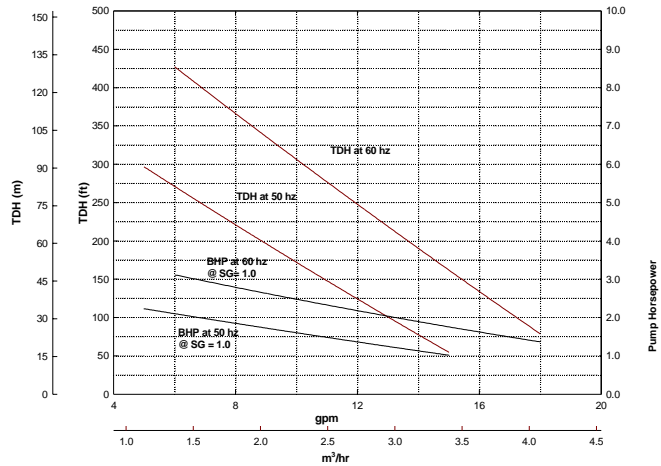

PT13 3450 & 2880 Curve

## Dynapump Motor Data

All motors are Class H Insulation:  
208-230/460V-3 $\phi$ -60Hz and 190/380V-3 $\phi$ -50Hz.

Rating	Input KW	FLA @ 230 V	Starting KVA
1.0 HP	1.29	3.80	5.10
1.5 HP	1.86	5.40	9.00
2.0 HP	2.37	7.00	10.80
3.0 HP	3.90	11.10	13.90
5.0 HP	5.00	14.70	25.40

## Dynapump Technical Data

Max Discharge Pressure: 225 PSIG  
Max Suction Pressure: 50 PSIG  
Operating Range: -50 to +300°F

## Dynapump Options

O-Rings: EPDM, Buna or Kalrez  
Motor Vent (Vertical or Side Mounting)  
Special Bearing Materials  
Mounting Base

## Dynapump Outline & Dimensions

PT13	1 - 11 1/2 NPT	1 - 11 1/2 NPT	1 3/8	3 3/4	1 3/8	4 3/16	N/A	N/A	N/A	N/A	N/A	N/A	10 1/2	12 3/4	11 1/2	13 3/4
PT10	1 - 11 1/2 NPT	1 - 11 1/2 NPT	1 3/8	3 3/4	1 3/8	4 3/16	N/A	N/A	N/A	N/A	N/A	N/A	10 1/2	12 3/4	11 1/2	13 3/4
PT8	1 - 11 1/2 NPT	1 - 11 1/2 NPT	1 3/8	3 3/4	1 3/8	4 3/16	N/A	N/A	N/A	N/A	10	12 1/4	10 1/2	12 3/4	11 1/2	13 3/4
PT6	1 - 11 1/2 NPT	1 - 11 1/2 NPT	1 3/8	3 3/4	1 3/8	4 3/16	N/A	N/A	9 1/2	11 3/4	10	12 1/4	10 1/2	12 3/4	N/A	N/A
PT4	1 - 11 1/2 NPT	1 - 11 1/2 NPT	1 3/8	3 3/4	1 3/8	4 3/16	8 1/2	10 3/4	9 1/2	11 3/4	10	12 1/4	N/A	N/A	N/A	N/A
PT3	3/4 - 14 NPT	3/4 - 14 NPT	1 3/16	3 1/4	1 1/4	4 1/16	8 1/2	10 3/4	9 1/2	11 3/4	10	12 1/4	N/A	N/A	N/A	N/A
MODEL	INLET	OUTLET	A	X	C	E	C	D	C	D	C	D	C	D	C	D
							1 HP MOTOR		1.5 HP MOTOR		2 HP MOTOR		3 HP MOTOR		5 HP MOTOR	

